

# CCD COLOR CAMERA CS9001/CS9001P SERIES INSTRUCTION MANUAL

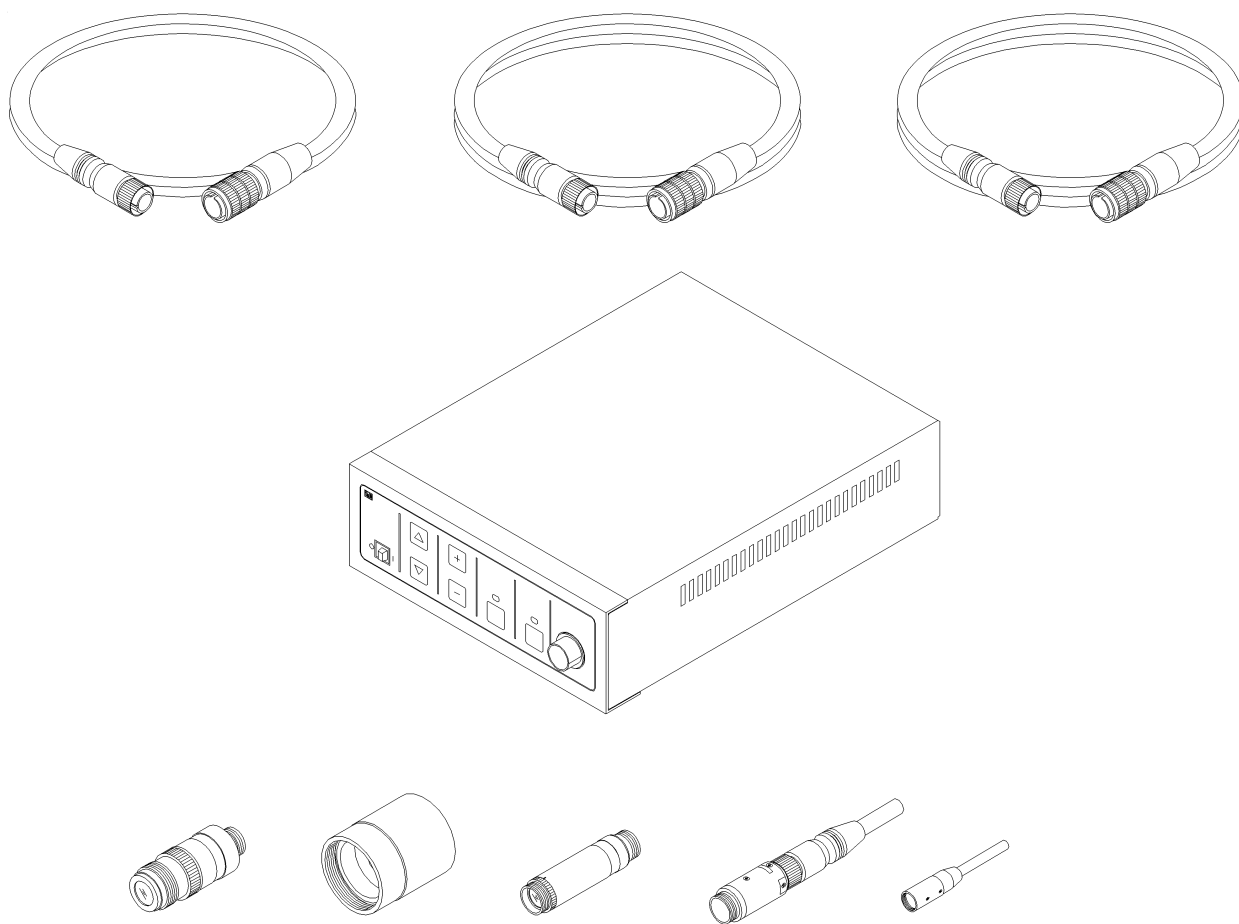

For customer Use:  
Enter below the Serial No. which is located on the rear panel of the camera control unit.  
Retain this information for future reference,  
Model name. \_\_\_\_\_  
Serial No. \_\_\_\_\_

**teli** TOKYO ELECTRONIC INDUSTRY CO., LTD.

This Instruction Manual is printed on recycled paper.

## CONTENTS



	Page
Important Safety Precautions	1
1. Introduction	8
2. Features	8
3. Components	9
3.1. CS9001 Series	9
3.2. CS9001P Series	10
3.3. Option	11
4. Names and Description of the Camera Controller	12
5. Menu Display Details	16
6. Connection	17
7. Operation	18
8. Before considering a failure has occurred	18
9. Specification	19
10. Attached Drawings	22
10.1. Typical spectral response	22
10.2. Camera Head Dimensions	23
10.3. Camera Controller Dimensions	25
10.4. Camera Cable Appearance	27
10.5. Camera Head Mounting Bracket Dimensions	27

## Important Safety Precautions

The main unit and the user's manual of the product provide information on important contents that will help prevent injury to those using the product and others, prevent property damage, and ensure safe use of the product. Please make yourself familiar with this information before using your CCD camera.

Make sure you understand the meaning of the indications and graphic symbols shown below before reading this manual. Be sure to observe the precautions indicated.





### ● Description of indications

Indication	Meaning of indication
 <b>DANGER</b>	Incorrect use or disregarding precautions may result in death or serious injury
 <b>WARNING</b>	Incorrect use or disregarding precautions may result in death or serious injury
 <b>CAUTION</b>	Incorrect use or disregarding precautions may result in personal injury (*1) or damage to property (*2).







\*1: Personal injury refers to injuries, burns, or electric shock that does not require hospitalization or repeated hospital visits.

\*2: Property damage refers to damage to assets or materials.







### ● Description of graphic symbols

Graphic symbol	Meaning of graphic symbol
	<b>Prohibited</b> – actions to be avoided at all times. The prohibited actions are indicated within or near the graphic symbol with illustrations or text.
	<b>Required</b> – actions that must be taken. The required actions are indicated within or near a graphic symbol with illustrations or text.
	<b>Hazardous.</b> The nature of the hazard is indicated within or near the graphic symbol with illustrations or text.
	<b>Caution.</b> The reason for the precaution indicated within or near the graphic symbol with illustrations or text.









[About Instructions in General]

 <b>DANGER</b>	
 Unplug	If by any chance an unusual odor, overheat or heat is found, turn off the power switch immediately and unplug the power cord from the power outlet. If you use it as is, this can cause fire, electric shock or product failure. Contact the sales distributor for repair. Any repair by the user is strictly prohibited because it is dangerous..
 Unplug	If a failure such as no image appears on the screen, turn off the power switch immediately and unplug the power cord from the power outlet. If you use it as is, this can cause fire, electric sock or product failure. Contact the sales distributor for repair. Any repair by the user is strictly prohibited because it is dangerous.
 Unplug	If a failure such as no image appears on the screen, turn off the power switch immediately and unplug the power cord from the power outlet. If you use it as is, this can cause fire, electric sock or product failure. Contact the sales distributor for repair. Any repair by the user is strictly prohibited because it is dangerous.
 Unplug	If by any chance a foreign object gets inside the product, turn off the power switch immediately and unplug the power cord from the power outlet. If you use it as is, this can cause fire or electric shock. Contact the sales distributor for repair.
 Unplug	If by any chance you have dropped the product or the case is damaged, turn off the power switch immediately and unplug the power cord from the power outlet. If you use it as is, this can cause fire or electric shock. Contact the sales distributor for repair.
 NEVER pull apart	The user must not disassemble, repair or modify the product. This can cause a failure of the product, erroneous operation or an accident. Contact the sales distributor for repair.





## [About Instructions in General]

 <b>DANGER</b>	
 Avoid	The camera cable, video output cable and power cord must not be handled roughly, damaged, fabricated, bent forcefully, pulled, twisted, bundled, placed under heavy objects or heated. If damaged, this can cause fire or electric shock. If the camera cable, video output cable or power cord is damaged, contact the sales distributor for repair.
 Avoid	Do not remove the cover of this product. This can cause electric shock. For inspection, adjustment or repair inside of the product, contact the sale distributor
 Avoid	Do not use voltage other than specified voltage (DC12 V). This can cause fire or electric shock.
 Avoid	Do not place the product on an unstable place such as a shaky table or a sloped location. If the product falls or topples down, this can cause injury.
 Avoid	Do not place a vase, flower pot, cup, toilet articles, vessels containing medicament or water, or small metal pieces on top of this product. If any of these spills or gets inside, this can cause fire or electric shock.
 Avoid	Do not insert or drop a foreign object such as a metal piece or highly combustible objects to inside of the product from a vent hole or other of this product. This causes a failure of the product or erroneous operation and can result in an accident. To repair the product, contact the sales distributor.

[About Instructions in General]

 <b>CAUTION</b>	
 Unplug	When you clean the product or not using the product for a long time, unplug the power cord from the power outlet for reason of safety. This can cause fire or electric shock.
 Avoid	To connect between the devices, make sure the power switch is turned off. This can cause electric shock.
 Avoid	To unplug the power cord from the power outlet, do not pull the cord. The cord may be damaged and this can cause fire or electric shock.
 Avoid	Do not unplug the power cord with wet hand. This can cause electric shock.
 Avoid	Do not block the vent hole of the product by putting a blanket over or placing another device close to the product. The temperature inside the product rises and this can cause fire.
 Avoid	Do not place this product, camera cable, video output cable or power cord close to a heating device. The sheath of the switch, cable or cord melts and this can cause fire or electric shock.
 Avoid	To clean this product, do not use benzine, alcohol, thinner and so on. This can cause painting or markings to peel off or degenerate.
 Caution	To insert or extract a connector, make sure the power of the camera controller is turned off beforehand. This can cause a failure of the product or electric shock.

## [About Instructions in General]

 <b>CAUTION</b>	
 Caution	If this product is to be used in an electric or magnetic field, beat noise (stripes generated vertically, horizontally and sideways) may occur in video output. In this case, take necessary action to dispose of the source of electromagnetic waves so that the product will not be affected by electromagnetic waves.
 Caution	Even when using this product repeatedly, observe the operating environmental condition (temperature and humidity). The temperature inside the product rises and this can cause fire.
 Caution	Do not install this product in a location where vibration is strong. This can cause a failure of the product.
 Caution	Do not apply strong shock to this product. This can cause a failure or damage to the product. In addition, if the product is used under environment where strong shock is applied to its connector, the connector can be damaged.
 Caution	Do not short the signal output. This can cause a failure of the product.
 Caution	Regardless of the operating condition of this product, do not direct the CCD camera toward the sun. This can cause a failure of the product.
 Caution	Even when this product is not used, place lens or lens cap so that dust does not collect and no scratches occur on the surface of the CCD camera. If stain occurs on the glass surface, wipe it off with a cotton swab or something. If solvent is required, do not use organic solvent other than ethyl alcohol. To prevent condensation, take necessary measures such as to cool when heated or warm when chilled before going in or out of the room with extreme temperatures.
 Caution	To install lens on the camera head, make sure the lens is not slanted before installing it on the camera head. In addition, use the one with no scratches or dust on the mounting threads. The camera may get stuck and not be removed.
 Required	To dispose of this product, follow the regulations of your state or the ordinance stipulated by local government. To prevent environmental contamination, excise the appropriate discriminative disposal method.

This equipment has been tested and found to comply with the limits for a class A digital device, pursuant to Part 15 of the FCC Rules. These limits are designed to provide reasonable protection against harmful interference when the equipment is operated in a commercial environment. This equipment generates, uses, and can radiate radio frequency energy and, if not installed and used in accordance with the instruction manual, may cause harmful interference to radio communication. Operation of this equipment in a residential area is likely to cause harmful interference in which case the user will be require to correct the interference at his own expense.

## **RESTRICTION FOR USE**

1. In case malfunction of this equipment (e.g. video output cut-off) can be expected to lead to significant accident, avoid using this equipment for such system build-in use.
2. Avoid irregular signal interface.
 

Do not attempt irregular signal interface other than specified. Under signal interface other than recommended/specified in this instruction manual, the device might fail to exert the maximum performance. In much worse case, if you continue to use your device under incorrect signal interface, part(s) of inner circuits might burn down.

## **DISCLAIMER (LIMITED WARRANTY)**

We disclaim any responsibility and shall be held harmless for damages or losses incurred by user(s) in either of the following cases.

1. In case damages or losses are caused by fire, earthquake, or other acts of Gods, the act by third party, misuse by the user deliberately or erroneously, use under extreme operating conditions.
2. In case any indirect, additional, consequential damages (loss of expected interest, suspension of business activities) are incurred as results of malfunction or non-function of this device, we shall be exempted from assuming responsibility for such damages.
3. In case damages or losses are caused by incorrect use which is not in line with the instructions given in this instruction manual.
4. In case damages or losses are caused by malfunction resulting from bad connection with other equipment.
5. In case damages or losses are caused by repair or modification done by the user.

## **OTHER INSTRUCTIONS**

### **Do NOT use power other than specified**

Be sure to use DC12V power supply. The camera is designed to work only under the specified voltage. Do NOT attempt to drive the camera with the power other than DC12V. Operating the camera under power other than DC12V invites a fire or a electric shock hazard.

### **Avoid intensive light**

Do NOT expose the camera's image-pickup-plane to sunlight or other intense light directly. If the part of CCD is exposed to spot-intensive light, you might get a picture problem like blooming and/or smear. You might observe vertical stripes on your monitor if your camera is exposed to sunlight (or any other intensive light), however, this is not a malfunction. Redirect your CH (camera-head) to different directions in such case.

### **Use under right operation condition**

This equipment is designed and guaranteed to work under the temperature range of 0 to 40 degrees C and 10 through 90% humidity range. Avoid using the equipment beyond that limits.

### **Handle with care**

Take care not to drop the equipment, nor give strong impact, as this may cause breakdown.

### **Do NOT tamper with switches**

Read this operation guide thoroughly before you touch switches and adjusters on the rear panel. Do NEVER attempt to disassemble the camera and/or tamper with any inner switches, potentiometers, etc.

### **Avoid liquid**

Avoid placing the camera where it is likely to be splashed with water or any other fluids. Operating the camera with its inner parts/circuits in an wet condition might cause a damage or an electric shock accident.

### **About camera cable**

The connector of the camera cable is in "screw-coupling" lock structure. Improper cramping might cause image noise. Be sure to give it a good cramping to avoid noise.

### **Camera cable connection/disconnection**

Before connecting/disconnecting connectors, make sure to turn camera power OFF. Otherwise, your camera might break down.

### **Avoid placing near TV/radio**

This camera might cause an interference (e.g. noise) if used around radio / TV set. In such a case, change the location of your camera (or radio / TV).

### **Abnormal operation**

In the event that any abnormal condition is observed, turn the power switch OFF immediately. Do NOT try to continue to use the camera. To do so reckless of visible signs of malfunction invites a fire, an electric shock hazard, or any other serious damage to the camera. In such case, contact us or our dealer/distributor

from which you purchased the camera for repair service.

## 1. Introduction

The CS9001/CS9001P Series is an NTSC/PAL separation method remote head type color camera and is adaptable to a variety of camera heads realizing ultra-small size and light weight.

## 2. Features

### (1) DC12 V Drive

Power voltage of this product is DC12 V suitable for assembly within a device. When the product is to be used under 100 to 240 VAC, it is recommended that you use an optional power adapter.

### (2) Camera head (the shape of CCU is common)

Four types of camera heads are provided to correspond to the size of CCD: 1/2, 1/3, 1/4 and 1/6.

For the shape of the head,  $\phi 17$  cylindrical type and  $\phi 29$  C-mount type are provided for Type 1/2,  $\phi 12$  cylindrical type for Type 1/3,  $\phi 12$  cylindrical type (camera cable directly connected) for Type 1/4, and  $\phi 7$  cylindrical type (camera cable directly connected) for Type 1/6. These combinations of camera heads can be used for a wide range of applications.

\* However, the camera head for Type 1/6 is used only for NTSC only.

### (3) External synchronization (CSU9001-01/CSU9001P-01 only)

Using an external synchronization signal as input, the synchronization method is automatically changed to remote mode.

When VBS, SYNC, HD/VD signal is used as the external synchronization signal, the horizontal and the vertical phases will be synchronized.

### (4) ALC (automatic light control)

Optimum image against extensive light intensity variation can be obtained with microcomputer-based control combining the high speed electronic shutter (ELC) with max speed of 100 hundred thousandth of a second and the automatic gain control (AGC). This is suitable for microscope applications with no lens aperture control or applications where brightness changes extensively.

### (5) Auto white balance

Burdensome white balance adjustment is not required by means of auto follow-up full automatic control that maintains appropriate white balance by detecting the color temperature variation of the subject at all times.

In addition, the set function to memorize and maintain the balanced white condition as well as the manual control of white balance can be made, which is convenient to obtain images under illumination with fixed color temperature used for image processing etc.

### (6) S terminal output

Y/C separation signal output (S terminal) is provided as well as VBS output.

By connecting the signal to an imaging device equipped with S terminal color monitor, clear images with less cross color can be obtained.

## (7) RGB output (CSU9001-01/CSU9001P-01 only)

RSB output useful for image processing is provided.

## (8) Various camera cables

Camera cables for  $\phi 17$ ,  $\phi 12$  cylindrical type (for Type 1/3) and C-mount type camera head include optional 3 m and 5 m length cables and they are available for each type.

In addition, camera cables for  $\phi 12$  cylindrical type (for Type 1/4) and  $\phi 7$  cylindrical type camera head are 3 m and 5 m length directly connected cables.

Furthermore, these can be combined with an extension camera cable of 7m.

### 3. Components

#### 3.1. CS9001 Series (NTSC)

## (1) Camera head , Camera cable

A combination of camera heads and camera cables are shown in the following table. Please specify the desired combination to our sales distributor when ordering.

Camera head					Camera cable
Individual product name	CCD Size	Dimensions	Lens mount	Accessories	
CSH9201	Type 1/2	$\phi 17$ mm	M15.5 P0.5 (Male thread)	None	The following camera cable (option) can be connected. - 3 m: CPRC4000B-03 - 5 m: CPRC4000B-05 - Extension 7 m: CPRC4000B-07J
CSH9221	Type 1/2	$\phi 29$ mm	C-mount	Lens Screw	
CSH9301	Type 1/3	$\phi 12$ mm	M10.5 P0.5 (Male thread)	None	
CSH9401-03 CSH9401-05	Type 1/4	$\phi 12$ mm	M10.5 P0.5 (Male thread)	None	3m and 5m cables are connected directly from the camera head. - 3 m : 03 (the last 2 digits of product name) - 5 m : 05 (the last 2 digits of product name) In addition, the cable can be extended with the cable below (option). - Extension 7 m: CPC4000B-07J
CSH9501-03 CSH9501-05	Type 1/6	$\phi 7$ mm	M6.3 P0.5 (Female thread)	None	

## (2) Camera controller

Camera controller					
Individual product name	Dimensions	Synchronous method	Video output	Consumption current	Accessories
CSU9001	120(W) × 41(H) × 156(D) mm	Internal synchronization	VBS OUT × 1 Y/C OUT × 1	550 mA	Instruction Manual
CSU9001-01		Internal synchronization /External synchronization	VBS OUT × 1 Y/C OUT × 1 RGB OUT × 1	680 mA	

### 3.2. CS9001P Series (PAL)

#### (1) Camera head , Camera cable

A combination of camera heads and camera cables are shown in the following table. Please specify the desired combination to our sales distributor when ordering.

Camera head					Camera cable
Individual product name	CCD Size	Dimensions	Lens mount	Accessories	
CSH9201P	Type 1/2	$\phi$ 17 mm	M15.5 P0.5 (Male thread)	None	The following camera cable (option) can be connected. - 3 m: CPRC4000B-03 - 5 m: CPRC4000B-05 - Extension 7 m: CPRC4000B-07J
CSH9221P	Type 1/2	$\phi$ 29 mm	C-mount	Lens Screw	
CSH9301P	Type 1/3	$\phi$ 12 mm	M10.5 P0.5 (Male thread)	None	
CSH9401P-03 CSH9401P-05	Type 1/4	$\phi$ 12 mm	M10.5 P0.5 (Male thread)	None	3m and 5m cables are connected directly from the camera head. - 3 m : 03 (the last 2 digits of product name) - 5 m : 05 (the last 2 digits of product name) In addition, the cable can be extended with the cable below (option). - Extension 7 m: CPC4000B-07J

#### (2) Camera controller

Camera controller					
Individual product name	Dimensions	Synchronous method	Video output	Consumption current	Accessories
CSU9001P	120(W) × 41(H) × 156(D) mm	Internal synchronization	VBS OUT × 1 Y/C OUT × 1	550 mA	Instruction Manual
CSU9001P-01		Internal synchronization /External synchronization	VBS OUT × 1 Y/C OUT × 1 RGB OUT × 1	680 mA	

### 3.3. Option

The following products are provided as option. (For details, contact our sales distributor.)

- (1) Camera cable : CPRC4000B-03 (3m)  
: CPRC4000B-05 (5m)
- (2) Extension camera cable : CPC4000B-07J (7m)
- (3) AC adapter : CA300
- (4) AC cord : APC1025-01P[for AC100V](2.5m)
- (5) RGB output cable (for CSU9001-01/CSU9001P-01)
- (6) Lens
- (7) Camera head fixture
- (8) C-mount adapter (for  $\phi$  17 mm,  $\phi$  12 mm)

#### **CAUTION: About option parts and EMC performance**

EMC performance of this product is guaranteed only when this product is combined with the option parts shown above. EMC performance when this product is combined with parts other than the ones specified by Teli shall not be guaranteed.

#### **CAUTION: Combination of camera heads and controllers**

Make sure to use the CSH9001(P) Series (camera head) combined with the CSU9001(P) or CSU9001(P)-01 (camera controller).

Do not combine the Teli's conventional CS9000(P) Series with them.

This can cause a failure of the product.

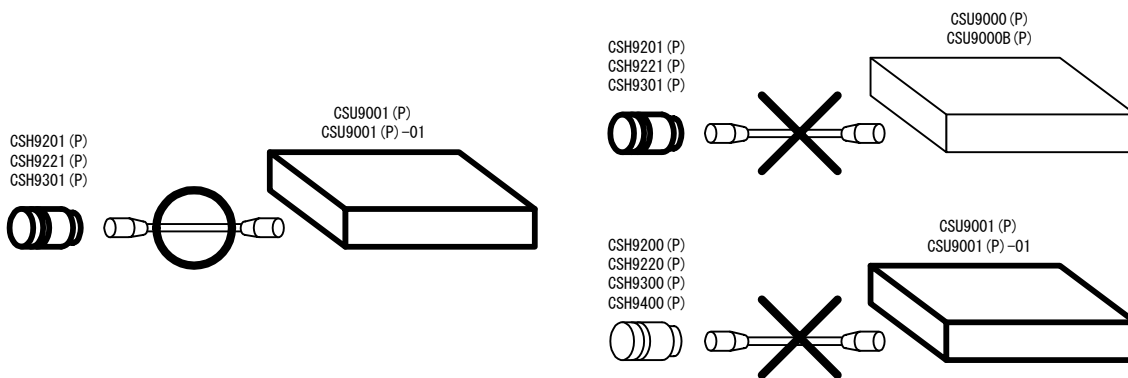

#### **CAUTION: About the camera head CSH9401(P)-03/05**

The camera head CSH9401(P)-03/05 is structured with its cable connected directly. Disassembly of the connector part is strictly prohibited.

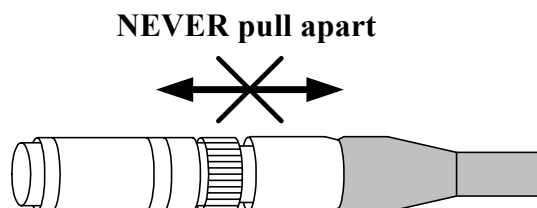



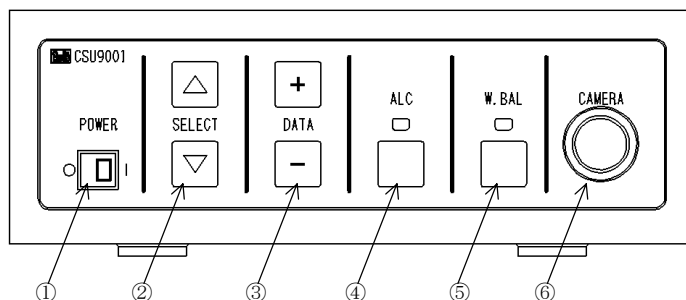

## 4. Names and Description of the Camera Controller

### (1) Front panel



Camera controller CSU9001(P)/CSU9001 (P)-01 Rear panel

- ① Power switch : Turns on or off the power to the camera.
- ② SELECT
  - (1)  key : Pressing the key once shows menu at the bottom right of the screen and pressing the key more than once changes the menu.
  - (2)  key : Pressing the key once shows menu at the bottom right of the screen and pressing the key more than once changes the menu.
- ③ DATA
  - (1)  key : Changes the setting value of the displayed menu.
  - (2)  key : Changes the setting value of the displayed menu.
- ④ ALC
 

ALC is the function to adjust the shutter speed and gain (video gain) automatically so that proper images in accordance with the brightness of the subject can be obtained. Use the ALC key on the front panel of the camera controller to set.

  - (1) ALC LED : Changes as follows with the set ALC mode  
lights (orange) ⇒ lights (green) ⇒ unlit
  - (2) ALC key : Used to change the ALC mode.

ALC MODE	LED	Shutter Speed	Gain	Description
ALC	Lights (green)	AUTO	AUTO	Automatically adjusts the shutter speed and gain (video gain) to obtain proper video level in accordance with the brightness of the subject. In this mode, the detection area can be set on the menu screen.
AGC	Lights (orange)	MANU	AUTO	Automatically adjusts only the gain (video gain) to obtain proper images in accordance with the brightness of the subject. However, the shutter speed becomes fixed. Adjust the speed on the menu screen to obtain proper video level.
MANU	Unlit	MANU	MANU	The shutter speed and gain become fixed. Adjust them on the menu screen while checking images on a video monitor etc.

## ⑤ W. BAL

- (1) W. BAL LED : Changes as follows in accordance with the set white balance mode  
lights (green) ⇒ lights (orange) ⇒ unlit
- (2) W. BAL key : Used to change the white balance mode.

This camera has the following modes to adjust white balance. Set the mode in accordance with the subject.

<b>WHITE BALANCE MODE</b>	<b>LED</b>	<b>Description</b>
<b>AUTO</b>	Lights (green)	At all times, adjusts white balance automatically. This is effective for the subject that changes its color temperature over time. However, since the color detection is made by means of integration, if illumination condition is bad (light intensity is too much or too little, or the color temperature shows extreme values), this mode may not work correctly.
<b>SET</b>	Lights (orange)	If the mode is changed from AUTO mode to this mode, the white balance condition at that time will be retained and memorized. After adjusting the white balance in the AUTO mode, change the mode to this mode. Even if power is turned on or off, white balance does not change.
<b>MANU</b>	Unlit	Using a white subject to obtain images, adjust proper value on the menu screen while checking images on a video monitor or a vector scope. This is effective to obtain images of the subject that does not change its color temperature over time.

- ⑥ Camera connector : Used to connect an optional camera cable.

(2) Rear panel

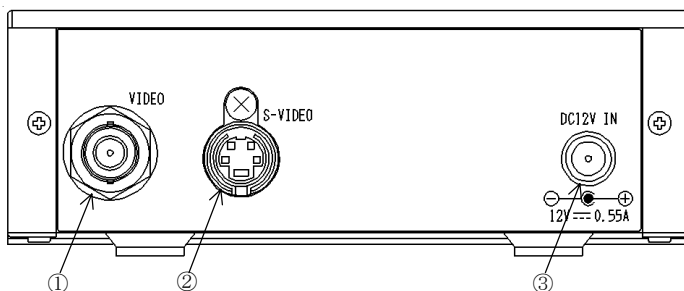

Camera controller CSU9001 (P) Rear panel

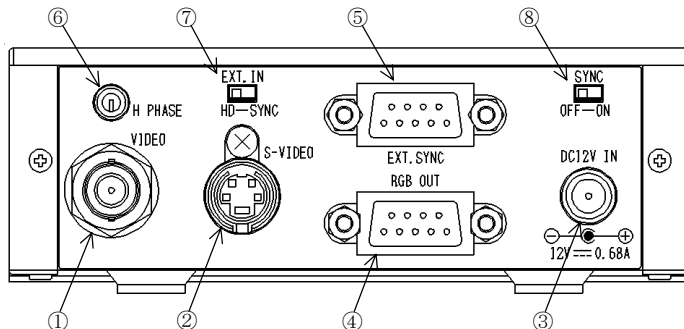

Camera controller CSU9001 (P)-01 Rear panel

- ① VIDEO : The output connector of the composite video signal to connect to a monitor etc.
- ② S-VIDEO : Y/C output connector to connect to a monitor etc.
- ③ DC12V IN : The connector to supply power to the controller.  
Mating plug : EIAJ RC-5320A Voltage category 4
- ④ RGB OUT : RGB/SYNC output connector and used to connect to a monitor etc.
- ⑤ EXT. SYNC : The input connector for an external synchronization signal.  
If the synchronization signal comes in, the system will be automatically controlled by the external synchronization signal.
- ⑥ H PHASE : Used to adjust the horizontal connection phase when external synchronization is used.(Input signal : HD/VD only)
- ⑦ EXT. IN : Used to set in accordance with the input signal when external synchronization is used.

Switch "EXT. IN," setting	Input signal
HD	HD/VD
SYNC	VBS or SYNC

- ⑧ SYNC : Changes G output SYNC attachment.

Switch "SYNC," setting	G output SYNC attachment
OFF	None
ON	Provided

● D-sub connector pin assignment

④ RGB OUT (female)

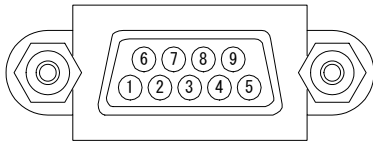

No.	Signal name
1	SYNC GND
2	R GND
3	R OUT
4	G OUT
5	B OUT
6	N.C.
7	SYNC OUT
8	G GND
9	B GND

⑤ EXT. SYNC (male)

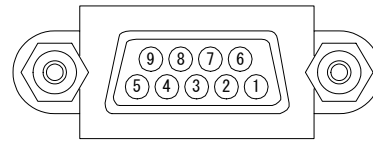

No.	Signal name
1	HD IN
2	VD IN
3	VBS IN/SYNC IN
4	N.C.
5	N.C.
6	GND
7	GND
8	GND
9	GND

## 5. Menu Display Details

SELECT Pressing the  $\triangle$  /  $\nabla$  key once shows menu at the bottom right of the screen.

Pressing the key as many times as necessary to display the desired item and change the setting with DATA  $\square$  + /  $\square$  - key.

No.	Display item	Details
1	DISP Clear	Clears the displayed item.
2	Shutter	<p>Sets the shutter speed.</p> <p>* <u>ALC MODE: Effective when AGC/MANU [ALC LED: lights (orange), unlit]</u></p> <p>0 = OFF            CS9001 Series: 1/60(S)            CS9001P Series: 1/50(S)</p> <p>1 = F. L            CS9001 Series : 1/100(S)            CS9001P Series: 1/120(S)</p> <p>2 = 1/250(S)            3 = 1/500(S)            4 = 1/1000(S)            5 = 1/2000(S)            6 = 1/4000(S)            7 = 1/10000(S)</p>
3	Gain	<p>Sets the gain of video signals.</p> <p>* <u>ALC MODE: Effective when MANU [ALC LED: unlit]</u></p> <p>0 = 0 dB (×1)            1 = +6 dB (×2)            2 = +12 dB (×4)</p>
4	ALC Level	<p>Sets the ALC video signal level.</p> <p>* <u>ALC MODE: Effective when ALC/AGC [ALC LED: lights (green, orange)]</u></p> <p>0 (dark) to 3 (factory shipped data) to 12 (bright)</p>
5	W.B. RED	<p>Sets the white balance RED.</p> <p>* <u>White balance: Effective when MANU [W. BAL LED: unlit]</u></p> <p>+32(R direction) to 0 (center: factory shipped data) to -32 (CY direction)</p>
6	W.B. BULE	<p>Sets the white balance BULE.</p> <p>* <u>White balance: Effective when MANU [W.BAL LED: unlit]</u></p> <p>+50 (B direction) to 0 (center: factory shipped data) to -50 (YL direction)</p>
7	AREA	<p>Sets the ALC detection area.</p> <p>* <u>ALC MODE: Effective when ALC [ALC LED: lights (green)]</u></p> <p>OFF = Full screen (factory shipped data)            ON = WIND (Fixed) (No window display)</p>
8	ENHANCE	<p>Sets the contour compensation level (H and V shared).</p> <p>0 (OFF) to 3 (factory shipped data) to 15</p>
9	SETUP	<p>Sets the setup (pedestal) value.</p> <p>0 to 8 (5 IRE: factory shipped data) to 15</p>
10	Gamma	<p>Sets the gamma value.</p> <p>OFF: <math>\gamma = 1</math>            ON : <math>\gamma = 0.45</math> (factory shipped data)</p>
11	Save	<p>Saves NO. 2 to No. 9 setting data to memory (USER AREA).            This is executed with DATA <math>\square</math> + key or <math>\square</math> - key.</p> <p><b><u>CAUTION: If power is turned off without executing this command, the changed data becomes invalid.</u></b></p>
12	Reset	<p>Read out the factory set data to memory (USER AREA).            This is executed with DATA <math>\square</math> + key or <math>\square</math> - key.</p> <p><b><u>CAUTION: If power is turned off without executing DATA Save command, the factory set data will not be saved to memory (USER AREA).</u></b></p>

## 6. Connection

Connect this product as follows:

(The following is just an example of connection. For details, please contact our sale distributor.)

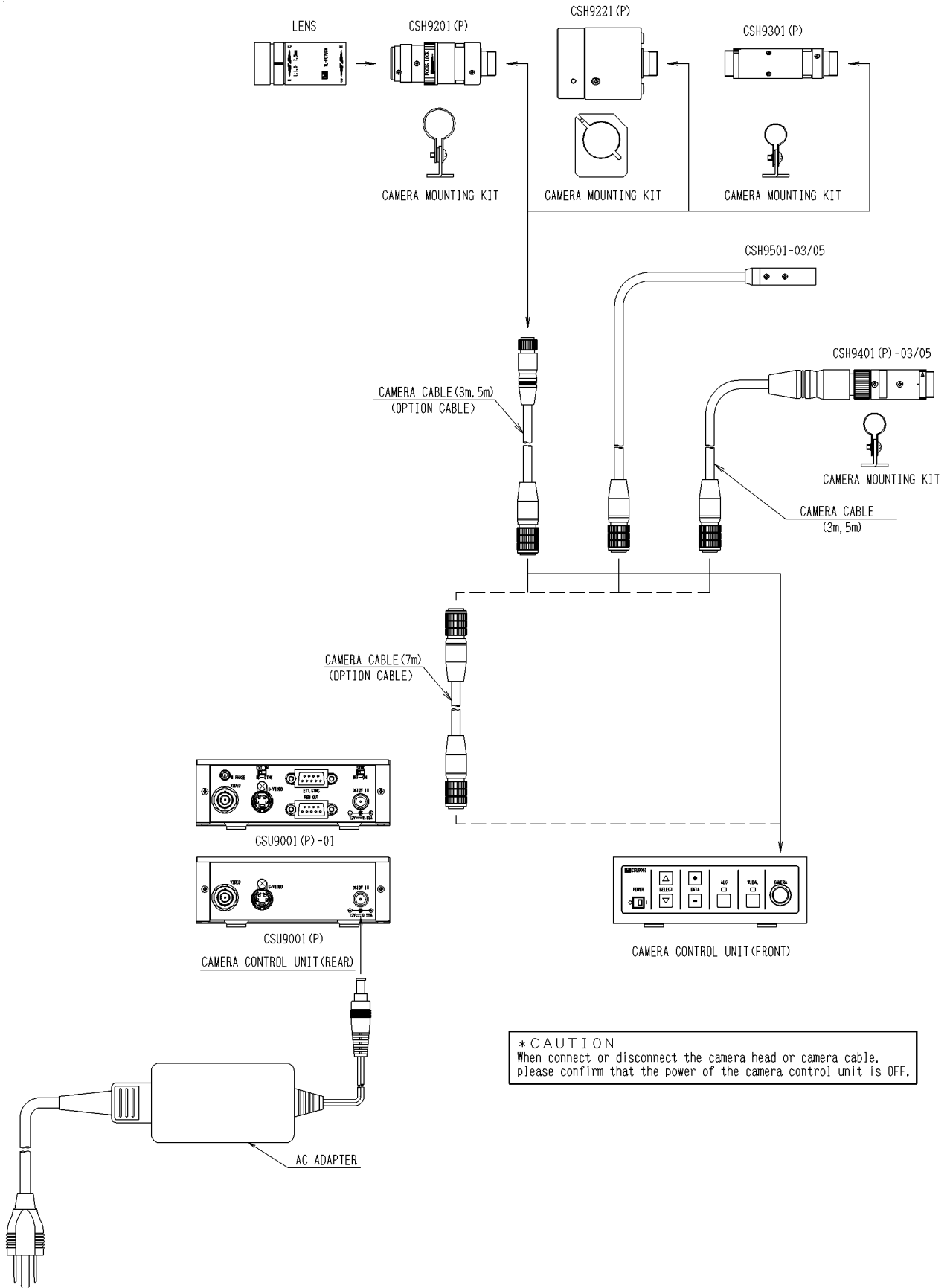

**\* CAUTION**  
When connect or disconnect the camera head or camera cable,  
please confirm that the power of the camera control unit is OFF.

## 7. Operation

- (1) See Section 6, “Connection” above to connect necessary devices correctly.
- (2) Turn on the power to the connected devices.
- (3) Turn on the power to this camera.
- (4) If any image appears on the video monitor, adjust the lens aperture control to obtain proper brightness.
- (5) While watching the image on the video monitor, adjust the lens focus to obtain the sharpest image.
- (6) White balance adjustment  
Adjust the white balance referring to ⑤W. BAL in Section 4, “Names and Description of Camera Controller.”
- (7) Mode setting  
Operate necessary items referring to ④ ALC in Section 4, “Names and Description of Camera Controller.” and Section 5, “Menu Display Details.”

## 8. Before considering a failure has occurred

Check the following items again before sending it for repair.

Symptom	Checking items
Power does not turn on.	- Is power supplied correctly? - Are camera head and camera cable connected correctly to the camera controller? (If not connected correctly, power to the camera does not turn on.)
Correct image does not appear.	- Is power supplied correctly? - Is lens aperture adjusted correctly? - Are cables connected correctly? - Are shutter speed and gain set correctly?
Color does not appear correctly.	- Is white balance adjusted correctly? - Isn't illumination too dark? - Is the monitor adjusted correctly?
Noise appears	- Isn't the connector of the camera cable loosened? - Isn't there something that generates strong magnetic fields nearby?

## 9. Specification

\* For items with no indication of head type name, the specification is the camera head CSH9221 or CSH9221P combined with a camera cable of 3 m.

No.	Model	CS9001 Series	CS9001P Series
1	TV system	NTSC	PAL
2	Image sensor		
	①CSH9201(P)	Type 1/2 Interline CCD	
	②CSH9221(P)	Type 1/2 Interline CCD	
	③CSH9301(P)	Type 1/3 Interline CCD	
	④CSH9401(P)-**	Type 1/4 Interline CCD	
	⑤CSH9501-**	Type 1/6 Interline CCD	
	Scanning area		
	①CSH9201(P)	6.45mm(H) × 4.84mm(V)	6.47mm(H) × 4.83mm(V)
	②CSH9221(P)	6.45mm(H) × 4.84mm(V)	6.47mm(H) × 4.83mm(V)
	③CSH9301(P)	4.88mm(H) × 3.66mm(V)	4.89mm(H) × 3.63mm(V)
	④CSH9401(P)-**	3.65mm(H) × 2.74mm(V)	3.65mm(H) × 2.71mm(V)
	⑤CSH9501-**	2.46mm(H) × 1.84mm(V)	
	Pixel size		
	①CSH9201(P)	8.40 μm(H) × 9.80 μm(V)	8.60 μm(H) × 8.30 μm(V)
	②CSH9221(P)	8.40 μm(H) × 9.80 μm(V)	8.60 μm(H) × 8.30 μm(V)
	③CSH9301(P)	6.35 μm(H) × 7.40 μm(V)	6.50 μm(H) × 6.25 μm(V)
	④CSH9401(P)-**	4.75 μm(H) × 5.55 μm(V)	4.85 μm(H) × 4.65 μm(V)
⑤CSH9501-**	3.20 μm(H) × 3.73 μm(V)		
Total pixels	811(H) × 508(V)	795(H) × 596(V)	
Active pixels	768(H) × 494(V)	752(H) × 582(V)	
Color filter	Corrective mosaic filter (Ye, Cy, Mg, G)		
CCD integration	Field integration (Field-electrical-charge-storage)		
3	Scanning lines	525 lines	625 lines
4	Scanning system	2:1 interlace	
5	Scanning frequency		
	Horizontal frequency	15.734kHz	15.625kHz
	Vertical frequency	59.94Hz	50Hz
6	Sync system		
	①CSU9001(P)	Internal	
	②CSU9001(P)-01	Internal/External automatic switch-over	
7	External sync input ※Only CSU9001-01 and CSU9001P-01		
	HD	4 ± 2V(p-p)/High Negative polarity 15.734kHz ± 50ppm	4 ± 2V(p-p)/High Negative polarity 15.625kHz ± 30ppm
	VD	4 ± 2V(p-p)/High Negative polarity 59.94Hz ± 50ppm	4 ± 2V(p-p)/High Negative polarity 50Hz ± 30ppm
	SYNC	2 ± 1 V(p-p)/75 Ω Negative polarity fH = 15.734kHz ± 50ppm fV = 59.94Hz ± 50ppm	2 ± 1 V(p-p)/75 Ω Negative polarity fH = 15.625kHz ± 30ppm fV = 50Hz ± 30ppm
	VBS	1 V(p-p)/75 Ω Negative polarity fH = 15.734kHz ± 50ppm fV = 59.94Hz ± 50ppm	1 V(p-p)/75 Ω Negative polarity fH = 15.625kHz ± 30ppm fV = 50Hz ± 30ppm
8	Aspect ratio	4:3	

No.	Model	CS9001 Series	CS9001P Series
9	Video output	※Only for CSU 9001-01 and CSU9001P-01, a RGB output is.	
	VBS	1.0 V(p-p)/75 Ω Positive polarity	
	Y/C VS	1.0 V(p-p)/75 Ω Positive polarity	
	C	0.286V(p-p)/75 Ω	0.3V(p-p)/75 Ω
	RGB VS	1.0 V(p-p)/75 Ω Positive polarity (Only G signal)	
	Y	0.714V(p-p)/75 Ω Positive polarity	0.7V(p-p)/75 Ω Positive polarity
10	External sync output	※Only CSU9001-01 and CSU9001P-01	
	SYNC	TTL level Negative polarity	
11	Sensitivity	F8, 3000K	
	①CSH9201(P)	700 lx	
	②CSH9221(P)	700 lx	
	③CSH9301(P)	950 lx	
	④CSH9401(P)-**	2000 lx	
	⑤CSH9501-**	3000 lx	
12	Minimum subject illumination	F1.4, 3000K,AGC ON, Output level: Approx. 50%	
	①CSH9201(P)	3 lx	
	②CSH9221(P)	3 lx	
	③CSH9301(P)	5 lx	
	④CSH9401(P)-**	8 lx	
	⑤CSH9501-**	12 lx	
13	S/N	46dB(p-p)/rms	
14	Resolution		
	Horizontal resolution	470 TV lines	460 TV lines
	Vertical resolution	350 TV lines	420 TV lines
15	Gamma	ON:0.45 / OFF:1 Selectable (Initial factory setting: ON :0.45)	
16	White balance	AUTO/SET/MANU (Initial factory setting: MANU)	
	Corrective range	2500K~6000K( (Detection area: Full screen)	
17	ALC	ALC/AGC/MANU selectable (Initial factory setting: MANU)	
	ALC setting	Corrective range: -6dB~+60dB	
		Detection area: Full screen/Wind (Initial factory setting: Full screen)	
	AGC setting	Corrective range: -6dB~0dB	
		Detection area: Full screen	
		Electronic shutter: 8 step selectable (1/60, 1/100, 1/250, 1/500, 1/1000, 1/2000, 1/4000, 1/10000s)	Electronic shutter: 8 step selectable (1/50, 1/120, 1/250, 1/500, 1/1000, 1/2000, 1/4000, 1/10000s)
MANU setting	Gain: 0dB/+6dB/+12dB selectable (Initial factory setting: 0dB)		
	Electronic shutter: 8 step selectable (1/60, 1/100, 1/250, 1/500, 1/1000, 1/2000, 1/4000, 1/10000s)	Electronic shutter: 8 step selectable (1/50, 1/120, 1/250, 1/500, 1/1000, 1/2000, 1/4000, 1/10000s)	
18	Pedestal	16 step selectable [0~8.5IRE] (Initial factory setting: 8=5IRE)	
19	Enhance	16 step selectable (Initial factory setting: 3)	
20	Lens mount		
	①CSH9201(P)	M15.5 P0.5 (Male thread)	
	②CSH9221(P)	C-mount	
	③CSH9301(P)	M10.5 P0.5 (Male thread)	
	④CSH9401(P)-**	M10.5 P0.5 (Male thread)	
	⑤CSH9501-**	M6.3 P0.5 (Female thread)	

No.	Model	CS9001 Series	CS9001P Series
21	Power source	DC12V ± 10% (Ripple voltage : 50mV(p-p))	
22	Power consumption	(DC12V)	
	①CSU9001(P)	Approx. 550mA	
	②CSU9001(P)-01	Approx. 680mA	
23	Ambient condition		
	Temperature	0°C ~ 40°C	
	Humidity	10 ~ 90% (No condensation)	
	Atmospheric pressure	500 ~ 1060hPa	
24	Outside size	Refer to outside drawing	
25	Weight		
	· Camera head		
	①CSH9201(P)	Approx. 16g	
	②CSH9221(P)	Approx. 45g	
	③CSH9301(P)	Approx. 11g	
	④CSH9401(P)-**	Approx. 9g (Cable is not included)	
	⑤CSH9501-**	Approx. 3g (Cable is not included)	
	· Camera controller		
	①CSU9001(P)	Approx. 600g	
②CSU9001(P)-01	Approx. 800g		
26	Application standard		
	CE	EMI	EN50081-1/1992
		EMS	EN50082-2/1995
	FCC	FCC Part15 subpart B Class A	

## 10. Attached Drawings

### 10.1. Typical spectral response

The lens characteristics and light source characteristics is not reflected in table.

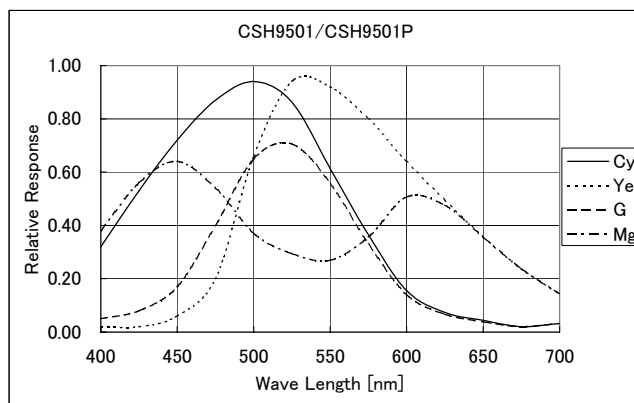
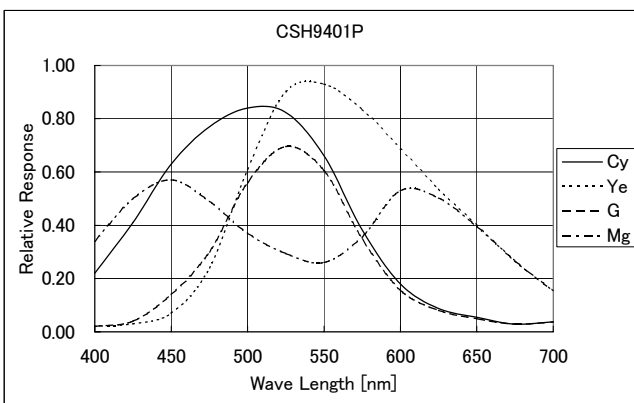
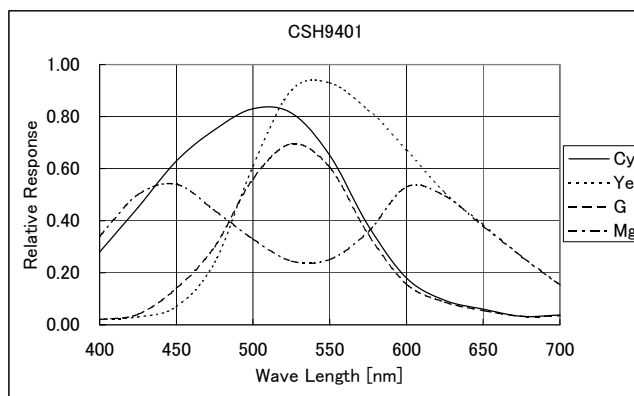
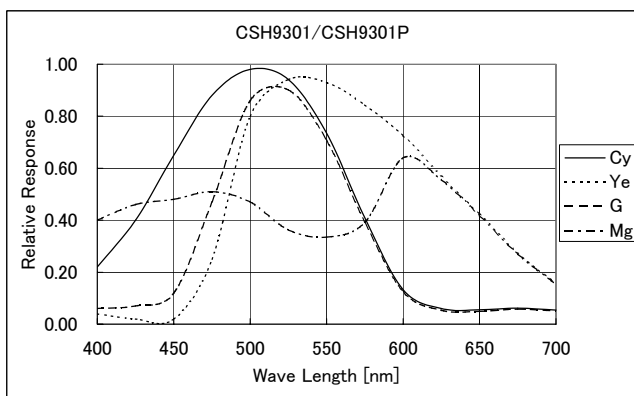
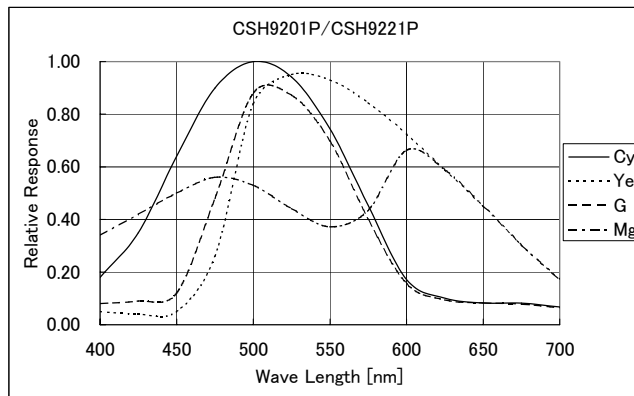
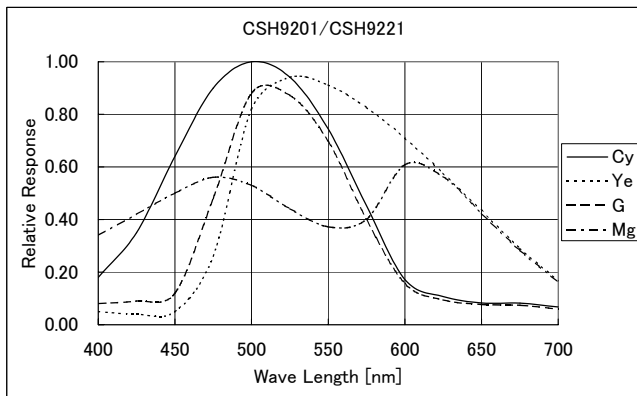



⑤ CSH9501-03/05

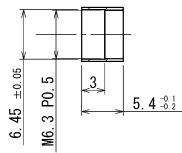
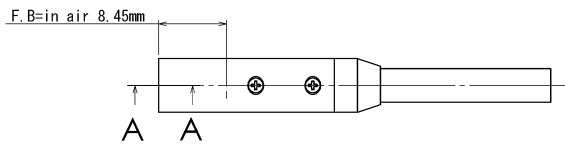
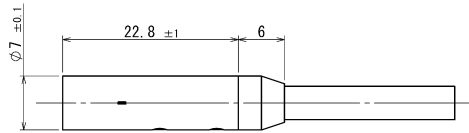

A-A Sectional view

### 10.3. Camera Controller Dimensions

①CSU9001(P)

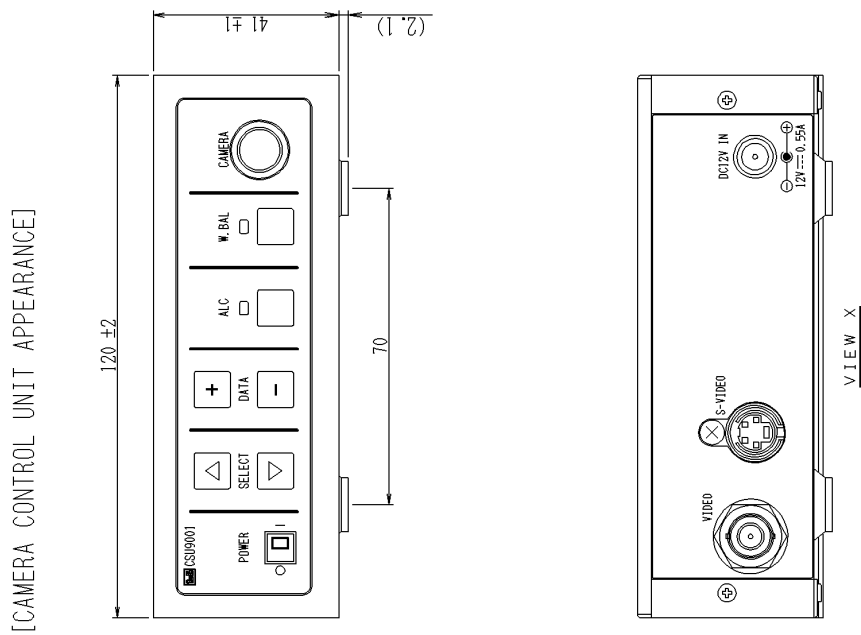
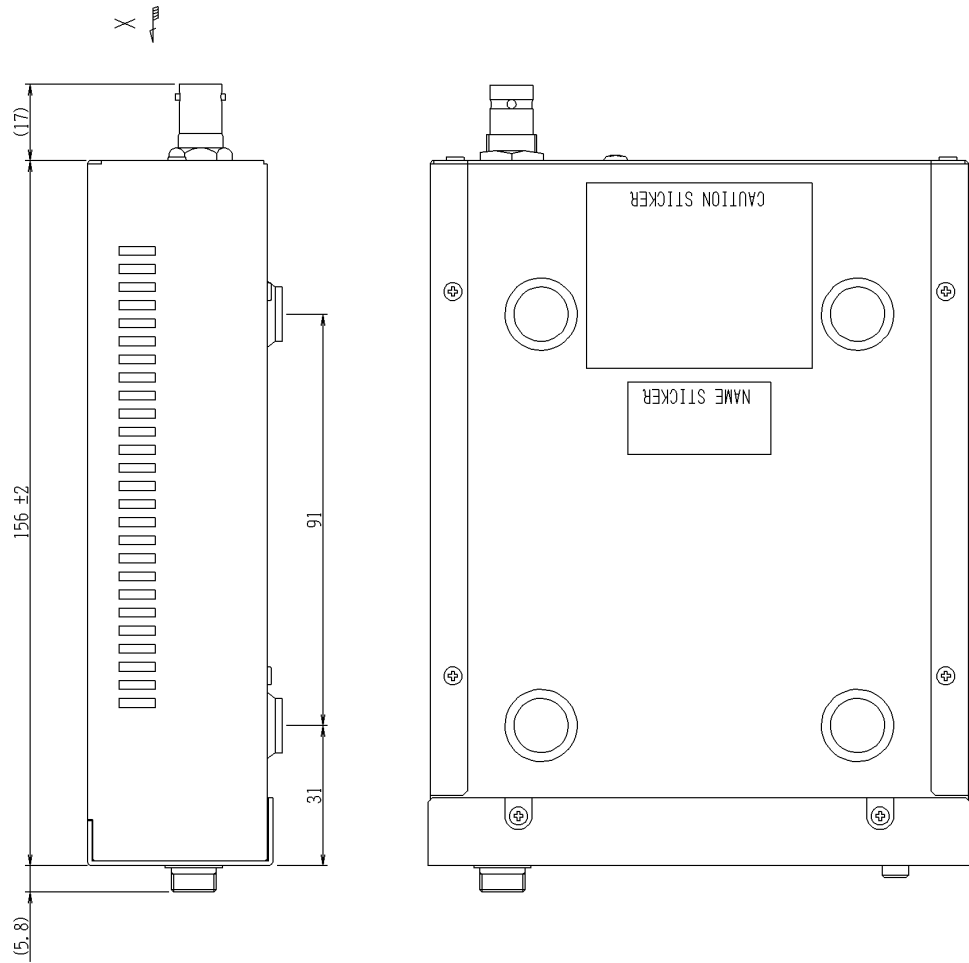

②CSU9001(P)-01

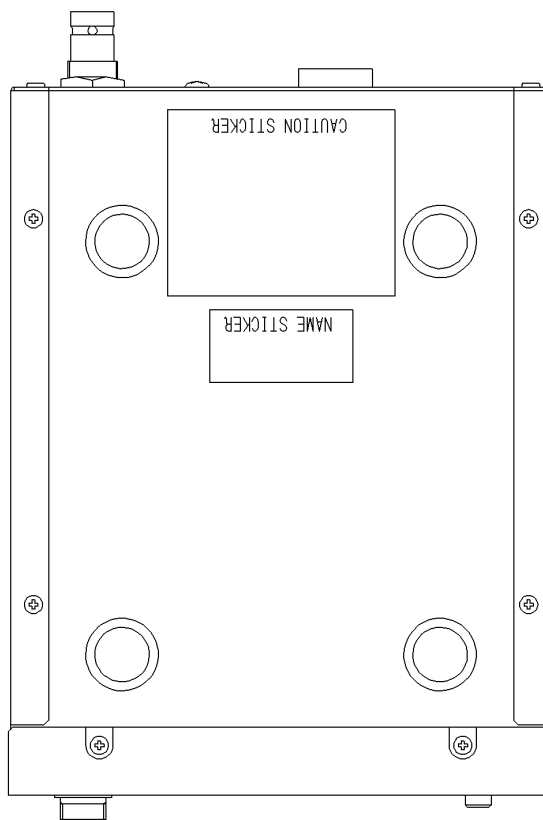
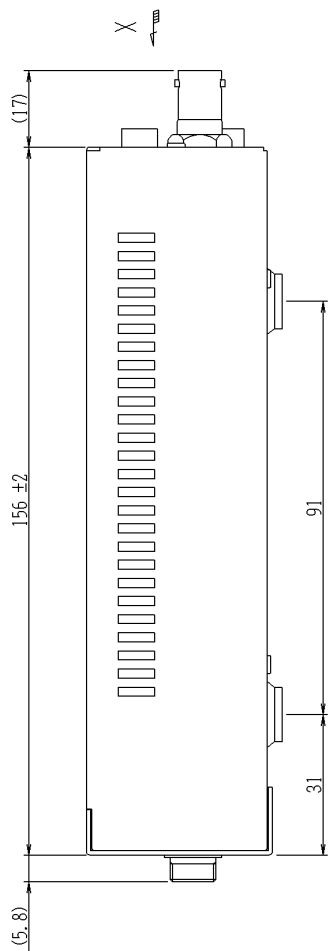

[CAMERA CONTROL UNIT APPEARANCE]

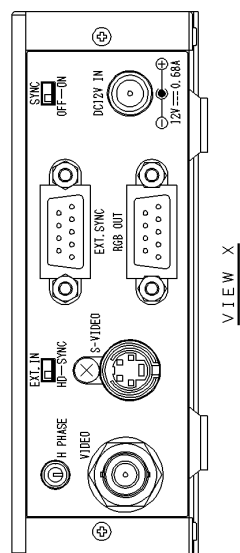
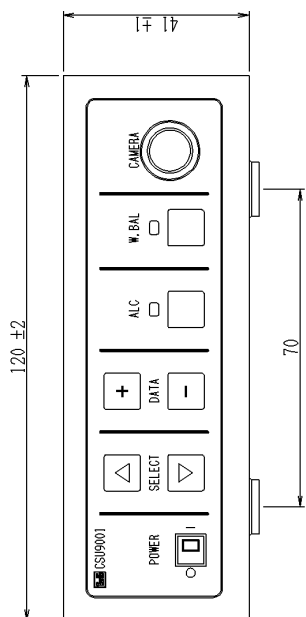

### 10.4. Camera Cable Appearance

①CPRC4000B-03/05

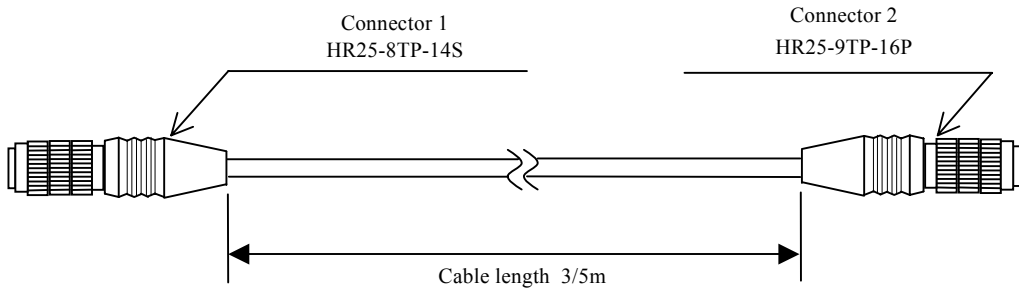

②CPC4000B-07J

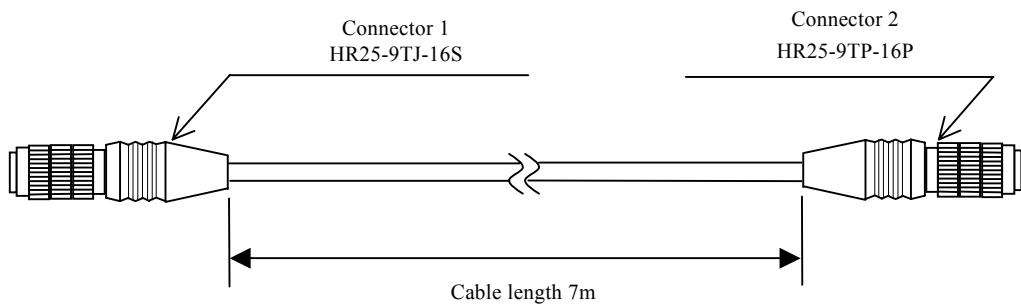

### 10.5. Camera Head Mounting Bracket Dimensions

[CAMERA MOUNTING KIT(OPTION) APPEARANCE]

CSH9201(P)

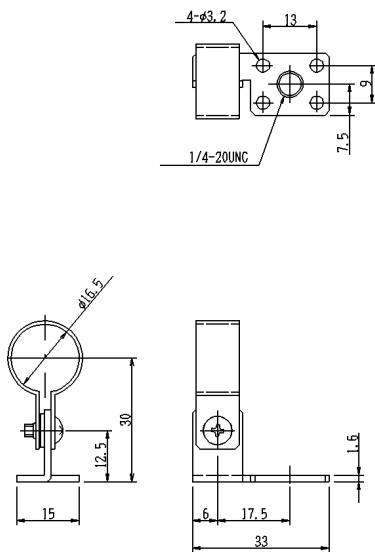

CSH9301(P)  
CSH9401(P)-03/05

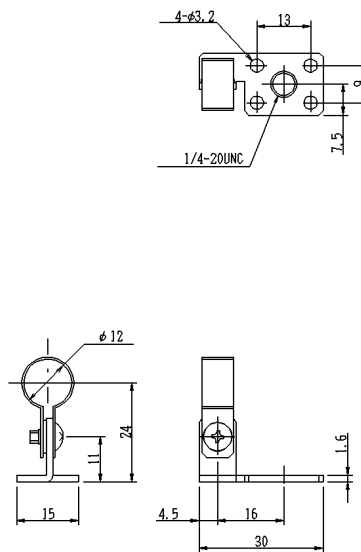

CS9221(P)

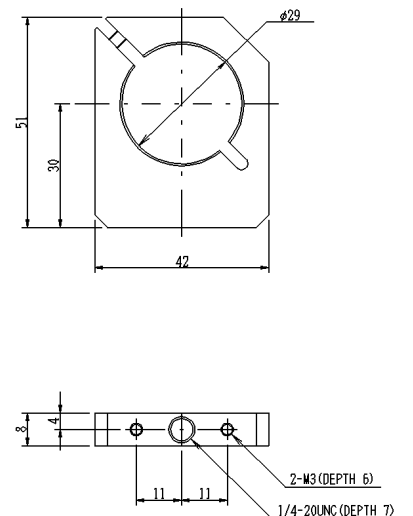



## **TOKYO ELECTRONIC INDUSTRY CO., LTD.**

**Sales Department Head Office:**

7-1, Asahigaoka 4-chome, Hino city, Tokyo 191-0065, Japan.

Phone:042(589)8771

Fax:042(589)8774

**Kansai Office:**

1-2, Sakaemachi-dori 2-chome, Chuo-ku, Kobe city 650-0023, Japan.

Phone:078(321)3461

Fax:078(321)3463

**Fukuoka Office:**

7-21, Hirao 3-chome, Chuo-ku, Fukuoka city 810-0014, Japan.

Phone:092(523)3395

Fax:092(523)3397